

规格书 | 型号: 2200-1201

2线普通接线端子; 有推压键; 1 mm²; 有测试插孔; 侧面/中心标记; 适于35 x 15
和 35 x 7.5导轨; Push-in CAGE CLAMP®; 1,00 mm²; 灰色

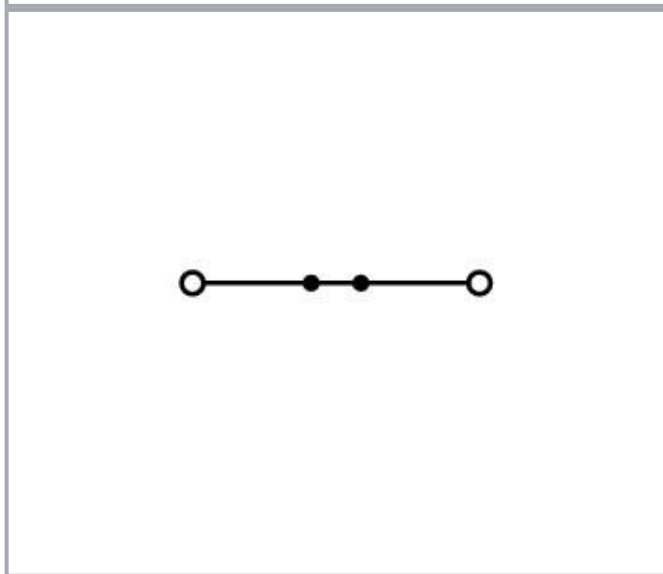

www.wago.com/2200-1201

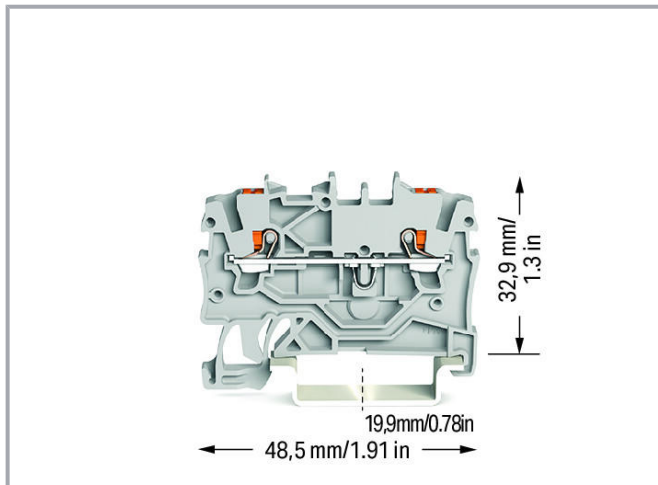
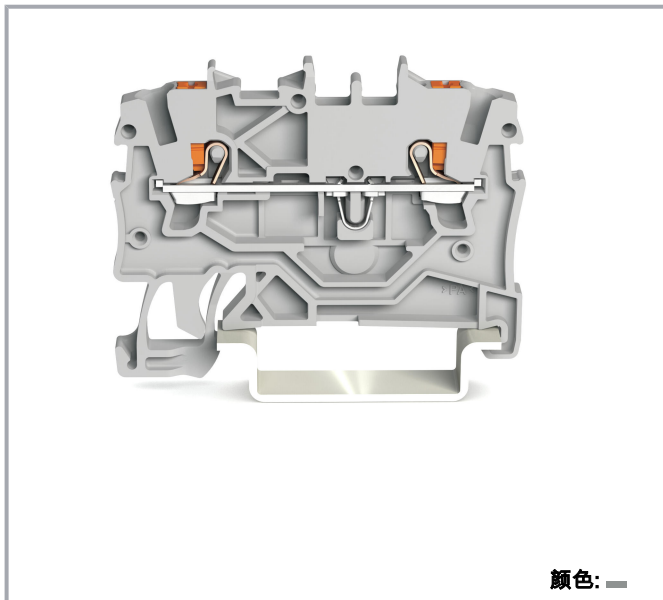

数据 电气参数

变更声明。 敬请关注进一步的产品说明文件！

WAGO Electronic (Tianjin) Co., Ltd.
No.5, Quan Hui Road
Wuqing Development Area | Tianjin 301700
Tel.: +86 22 59677688 | Fax: +86 22 59617668
Email: info-cn@wago.com

您有关于我们产品的任何问题吗？
我们非常乐意接听您的来电， +86 (022) 59677688。

Ratings per IEC/EN

额定电气参数依据的标准	IEC/EN 60947-7-1
额定电压(III/3)	800 V
额定浪涌电压(III/3)	8 kV
额定电流	13.5 A
额定电流2	17.5 A
图例(额定电气参数)	(III / 3) Δ 过电压类别III/污染等级3

Approvals per UL

认证	UL 1059
额定电压 UL(Use Group B)	600 V
额定电流 UL(Use Group B)	10 A
额定电压 UL(Use Group C)	600 V
额定电流 UL(Use Group C)	10 A

Approvals per CSA

认证	C22.2 No 158
额定电压 CSA (Use Group B)	600 V
额定电流 CSA (Use Group B)	10 A
额定电压 CSA (Use Group C)	600 V
额定电流 CSA (Use Group C)	10 A

Ex information

Ratings per	ATEX: PTB 18 ATEX 1004 U / IECEx: PTB 18.0010U (Ex eb IIC Gb)
额定电压EN (Ex e II)	550 V
额定电流(Ex e II)	13 A
带跨接器时的额定电流((Ex e II)	12 A

接线参数

连接技术	直插型笼式弹簧接线单元(Push-in CAGE CLAMP®)
执行类型	推入式 推压键 操作工具
可连接导线材料	铜
额定导线截面积	1 mm ²

变更声明。 敬请关注进一步的产品说明文件！

WAGO Electronic (Tianjin) Co., Ltd.
No.5, Quan Hui Road
Wuqing Development Area | Tianjin 301700
Tel.: +86 22 59677688 | Fax: +86 22 59617668
Email: info-cn@wago.com

您有关于我们产品的任何问题吗？
我们非常乐意接听您的来电， +86 (022) 59677688。

单股导线	0.14 ... 1.5 mm ² / 24 ... 16 AWG
单股导线 ; 可直接插入	0.5 ... 1.5 mm ² / 20 ... 16 AWG
细多股导线	0.14 ... 1.5 mm ² / 24 ... 16 AWG
细多股导线 ; 加有带绝缘护套的冷压接头	0.14 ... 0.75 mm ² / 24 ... 18 AWG
细多股导线 ; 加有冷压接头 ; 可直接插入	0.5 ... 0.75 mm ² / 20 ... 18 AWG
说明(导线截面积)	横截面较小的导线也可以直接插入,具体取决于导线特性。
剥线长度	9 ... 11 mm / 0.35 ... 0.43 英寸
连接点总数	2
电位总数量	1
层数	1
接线类型	正面接线
跨接器插孔数量	2

Geometrical Data

宽度	3.5 mm / 0.138 inch
高度	48.5 mm / 1.909 inch
以DIN导轨的上边线为基准的深度	32.9 mm / 1.295 inch

机械参数

设计	水平型
安装方式	DIN-35型导轨
标记位	中央/侧面标记位

材料参数

颜色	灰色
绝缘材料	尼龙66 (PA 66)
重量	3.5 g

商业数据

包装类型	BOX
原产国	DE
GTIN	4055143691543
海关税号	85369010000

认证 / 证书

Ex防爆认证

变更声明。 敬请关注进一步的产品说明文件！

WAGO Electronic (Tianjin) Co., Ltd.
No.5, Quan Hui Road
Wuqing Development Area | Tianjin 301700
Tel.: +86 22 59677688 | Fax: +86 22 59617668
Email: info-cn@wago.com

您有关于我们产品的任何问题吗？
我们非常乐意接听您的来电， +86 (022) 59677688。

标识	认证	其他认证信息	认证名称
	AEx Underwriters Laboratories Inc.	UL 60079	4788311594
	ATEX Physikalisch Technische Bundesanstalt	IEC 60079-0	PTB 18 ATEX 1003 U
	CCCEX CQST/CNEx	CNCA-C23-01	202031231000166
	EAC Brjansker Zertifizierungsstelle	TP TC 012/2011	RU C-DE.AM02.B. 00127/19
	IECEX Physikalisch Technische Bundesanstalt	IEC 60079	IECEX PTB 18.0010U (Ex eb IIC Gb and Ex eb I Mb)

船级社认证

标识	认证	其他认证信息	认证名称
	CCA DEKRA Certification B.V.	EN 60947	NTR NL 7663
	CSA DEKRA Certification B.V.	C22.2	70173737
	KEMA/KEUR DEKRA Certification B.V.	IEC 60947	71- 102874

船级社认证

标识	认证	其他认证信息	认证名称
	ABS American Bureau of Shipping	-	19- HG1866350- PDA

变更声明。敬请关注进一步的产品说明文件！

WAGO Electronic (Tianjin) Co., Ltd.
No.5, Quan Hui Road
Wuqing Development Area | Tianjin 301700
Tel.: +86 22 59677688 | Fax: +86 22 59617668
Email: info-cn@wago.com

您关于我们产品的任何问题吗？
我们非常乐意接听您的来电，+86 (022) 59677688。



DNV GL
Det Norske Veritas, Germanischer Lloyd

-

TAE00003JT



LR
Lloyds Register

-

19/20050

UL-Approvals

标识	认证	其他认证信息	认证名称
	cURus Underwriters Laboratories Inc.	UL 1059	4788311592

所需附件

End plate

	型号: 2000-1291 端板和隔板; 厚度 0.7 mm; 灰色	www.wago.com/2000-1291
	型号: 2000-1292 端板和隔板; 厚度 0.7 mm; 橙色	www.wago.com/2000-1292

适用产品

Marking accessories

	型号: 2009-110 标记条; 适于Smart Printer; 卷装; not stretchable; 空白; 卡装式; 白色	www.wago.com/2009-110
	型号: 2009-113 WMB-Inline; 适于Smart Printer; 每卷2300个标记; 空白; 卡装式; 白色	www.wago.com/2009-113
	型号: 2009-113/000-002 WMB-Inline; 适于Smart Printer; 每卷2300个标记; 空白; 卡装式; 黄色	www.wago.com/2009-113/000-002
	型号: 2009-113/000-005 WMB-Inline; 适于Smart Printer; 每卷2300个标记; 空白; 卡装式; 红色	www.wago.com/2009-113/000-005
	型号: 2009-113/000-006 WMB-Inline; 适于Smart Printer; 每卷2300个标记; 空白; 卡装式; 蓝色	www.wago.com/2009-113/000-006

变更声明。敬请关注进一步的产品说明文件！

WAGO Electronic (Tianjin) Co., Ltd.
No.5, Quan Hui Road
Wuqing Development Area | Tianjin 301700
Tel.: +86 22 59677688 | Fax: +86 22 59617668
Email: info-cn@wago.com

您有关于我们产品的任何问题吗？
我们非常乐意接听您的来电， +86 (022) 59677688。

	型号: 2009-113/000-007 WMB-Inline; 适于Smart Printer; 每卷2300个标记; 空白; 卡装式; 灰色	www.wago.com/2009-113/000-007
	型号: 2009-113/000-012 WMB-Inline; 适于Smart Printer; 每卷2300个标记; 空白; 卡装式; 橙色	www.wago.com/2009-113/000-012
	型号: 2009-113/000-017 WMB-Inline; 适于Smart Printer; 每卷2300个标记; 空白; 卡装式; 浅绿色	www.wago.com/2009-113/000-017
	型号: 2009-113/000-023 WMB-Inline; 适于Smart Printer; 每卷2300个标记; 空白; 卡装式; 绿色	www.wago.com/2009-113/000-023
	型号: 2009-113/000-024 WMB-Inline; 适于Smart Printer; 每卷2300个标记; 空白; 卡装式; 紫色	www.wago.com/2009-113/000-024
	型号: 793-3501 WMB标记卡; 详见卡片; 空白; 卡装式; 白色	www.wago.com/793-3501
Carrier rail		
	型号: 210-112 钢质导轨; 35 x 7.5 mm; 厚度 1 mm; 长度 2 m; 带孔; 符合 EN 60715标准; "孔宽25 mm; 银色	www.wago.com/210-112
	型号: 210-113 钢质导轨; 35 x 7.5 mm; 厚度 1 mm; 长度 2 m; 不带孔; 符合 EN 60715标准; 银色	www.wago.com/210-113
	型号: 210-114 钢质导轨; 35 x 15 mm; 厚度 1.5 mm; 长度 2 m; 不带孔; 类似于EN 60715; 银色	www.wago.com/210-114
	型号: 210-115 钢质导轨; 35 x 7.5 mm; 厚度 1 mm; 长度 2 m; 带孔; 符合 EN 60715标准; "孔宽18 mm; 银色	www.wago.com/210-115
	型号: 210-118 钢质导轨; 35 x 15 mm; 厚度 2.3 mm; 长度 2 m; 不带孔; 符合 EN 60715标准; 银色	www.wago.com/210-118
	型号: 210-196 铝质导轨; 35 x 8.2 mm; 厚度 1.6 mm; 长度 2 m; 不带孔; 类似于EN 60715; 银色	www.wago.com/210-196
	型号: 210-197 钢质导轨; 35 x 15 mm; 厚度 1.5 mm; 长度 2 m; 带孔; 类似于EN 60715; 银色	www.wago.com/210-197
	型号: 210-198 铜质导轨; 35 x 15 mm; 厚度 2.3 mm; 长度 2 m; 不带孔; 符合 EN 60715标准; 铜色	www.wago.com/210-198
Push-In type wire jumper		
	型号: 2009-402 推入式跨接器; 0.75 mm ² ; 绝缘; 长度60 mm; 灰色	www.wago.com/2009-402
	型号: 2009-404 推入式跨接器; 0.75 mm ² ; 绝缘; 长度110 mm; 灰色	www.wago.com/2009-404

变更声明。敬请关注进一步的产品说明文件！

WAGO Electronic (Tianjin) Co., Ltd.
No.5, Quan Hui Road
Wuqing Development Area | Tianjin 301700
Tel.: +86 22 59677688 | Fax: +86 22 59617668
Email: info-cn@wago.com

您有关于我们产品的任何问题吗？
我们非常乐意接听您的来电， +86 (022) 59677688。

	型号: 2009-406 推入式跨接器; 0.75 mm ² ; 绝缘; 长度250 mm; 灰色	www.wago.com/2009-406
check		
	型号: 2000-510 TOPJOB@S L型测试插头模块; 模块化; 适用于跨接器接点槽; 1,00 mm ² ; 灰色	www.wago.com/2000-510
	型号: 2000-511 TOPJOB@S L型测试插头模块; 模块化; 适用于跨接器接点槽; 1极; 1,00 mm ² ; 灰色	www.wago.com/2000-511
	型号: 2000-549 间隔模块; 模块化; 例如, 用于间隔已跨接的接线端子; 灰色	www.wago.com/2000-549
	型号: 2000-552 模块化TOPJOB@S连接器; 模块化; 适用于跨接器接点槽; 2极; 1,00 mm ² ; 灰色	www.wago.com/2000-552
	型号: 2000-553 模块化TOPJOB@S连接器; 模块化; 适用于跨接器接点槽; 3极; 1,00 mm ² ; 灰色	www.wago.com/2000-553
	型号: 2000-554 模块化TOPJOB@S连接器; 模块化; 适用于跨接器接点槽; 4极; 1,00 mm ² ; 灰色	www.wago.com/2000-554
	型号: 2000-555 模块化TOPJOB@S连接器; 模块化; 适用于跨接器接点槽; 5极; 1,00 mm ² ; 灰色	www.wago.com/2000-555
	型号: 2000-556 模块化TOPJOB@S连接器; 模块化; 适用于跨接器接点槽; 6极; 1,00 mm ² ; 灰色	www.wago.com/2000-556
	型号: 2000-557 模块化TOPJOB@S连接器; 模块化; 适用于跨接器接点槽; 7极; 1,00 mm ² ; 灰色	www.wago.com/2000-557
	型号: 2000-558 模块化TOPJOB@S连接器; 模块化; 适用于跨接器接点槽; 8极; 1,00 mm ² ; 灰色	www.wago.com/2000-558
	型号: 2000-559 模块化TOPJOB@S连接器; 模块化; 适用于跨接器接点槽; 9极; 1,00 mm ² ; 灰色	www.wago.com/2000-559
	型号: 2000-560 模块化TOPJOB@S连接器; 模块化; 适用于跨接器接点槽; 10极; 1,00 mm ² ; 灰色	www.wago.com/2000-560
	型号: 2009-174 测试插头适配器; 适于测试插头4 mm Ø; 用于测试 TOPJOB@S 轨道式端子板; 灰色	www.wago.com/2009-174
	型号: 2009-182 测试插头; 适用最大 2.5 mm ² ; 可不使用任何工具与单根测试导线 (0.08 - 2.5 mm ²) 连接; 灰色	www.wago.com/2009-182
	型号: 210-136 测试插头; 2 mm Ø; 带500 mm长电缆; 红色	www.wago.com/210-136
tools		
	型号: 210-647 操作工具; 刀口尺寸 : 2.5 x 0.4 mm; 带有绝缘手柄; 多种颜色	www.wago.com/210-647

变更声明。敬请关注进一步的产品说明文件！

WAGO Electronic (Tianjin) Co., Ltd.
No.5, Quan Hui Road
Wuqing Development Area | Tianjin 301700
Tel.: +86 22 59677688 | Fax: +86 22 59617668
Email: info-cn@wago.com

您有关于我们产品的任何问题吗？
我们非常乐意接听您的来电， +86 (022) 59677688。

**型号: 210-648**

操作工具; 刀口尺寸 : 2.5 x 0.4 mm; 带有绝缘手柄; 弯角; 短

www.wago.com/210-648**型号: 210-719**

操作工具; 刀口尺寸 : 2.5 x 0.4 mm; 带有绝缘手柄

www.wago.com/210-719**Jumper****型号: 2000-402**

跨接器; 2插脚; 绝缘; 浅灰色

www.wago.com/2000-402**型号: 2000-402/000-005**

跨接器; 2插脚; 绝缘; 红色

www.wago.com/2000-402/000-005**型号: 2000-402/000-006**

跨接器; 2插脚; 绝缘; 蓝色

www.wago.com/2000-402/000-006**型号: 2000-402/000-018**

跨接器; 2插脚; 绝缘; 黄绿色

www.wago.com/2000-402/000-018**型号: 2000-403**

跨接器; 3插脚; 绝缘; 浅灰色

www.wago.com/2000-403**型号: 2000-403/000-005**

跨接器; 3插脚; 绝缘; 红色

www.wago.com/2000-403/000-005**型号: 2000-403/000-006**

跨接器; 3插脚; 绝缘; 蓝色

www.wago.com/2000-403/000-006**型号: 2000-404**

跨接器; 4插脚; 绝缘; 浅灰色

www.wago.com/2000-404**型号: 2000-404/000-005**

跨接器; 4插脚; 绝缘; 红色

www.wago.com/2000-404/000-005**型号: 2000-404/000-006**

跨接器; 4插脚; 绝缘; 蓝色

www.wago.com/2000-404/000-006**型号: 2000-405**

跨接器; 5插脚; 绝缘; 浅灰色

www.wago.com/2000-405**型号: 2000-405/000-005**

跨接器; 5插脚; 绝缘; 红色

www.wago.com/2000-405/000-005**型号: 2000-405/000-006**















跨接器; 5插脚; 绝缘; 蓝色

www.wago.com/2000-405/000-006

变更声明。 敬请关注进一步的产品说明文件！

WAGO Electronic (Tianjin) Co., Ltd.
No.5, Quan Hui Road
Wuqing Development Area | Tianjin 301700
Tel.: +86 22 59677688 | Fax: +86 22 59617668
Email: info-cn@wago.com

您关于我们产品的任何问题吗？
我们非常乐意接听您的来电， +86 (022) 59677688。

	型号: 2000-405/011-000 起点跨接器; 3插脚; 绝缘; 浅灰色	www.wago.com/2000-405/011-000
	型号: 2000-406 跨接器; 6插脚; 绝缘; 浅灰色	www.wago.com/2000-406
	型号: 2000-406/000-005 跨接器; 6插脚; 绝缘; 红色	www.wago.com/2000-406/000-005
	型号: 2000-406/000-006 跨接器; 6插脚; 绝缘; 蓝色	www.wago.com/2000-406/000-006
	型号: 2000-406/020-000 三角形接法跨接器; 绝缘; 浅灰色	www.wago.com/2000-406/020-000
	型号: 2000-407 跨接器; 7插脚; 绝缘; 浅灰色	www.wago.com/2000-407
	型号: 2000-407/000-005 跨接器; 7插脚; 绝缘; 红色	www.wago.com/2000-407/000-005
	型号: 2000-407/000-006 跨接器; 7插脚; 绝缘; 蓝色	www.wago.com/2000-407/000-006
	型号: 2000-408 跨接器; 8插脚; 绝缘; 浅灰色	www.wago.com/2000-408
	型号: 2000-408/000-005 跨接器; 8插脚; 绝缘; 红色	www.wago.com/2000-408/000-005
	型号: 2000-408/000-006 跨接器; 8插脚; 绝缘; 蓝色	www.wago.com/2000-408/000-006
	型号: 2000-409 跨接器; 9插脚; 绝缘; 浅灰色	www.wago.com/2000-409
	型号: 2000-409/000-005 跨接器; 9插脚; 绝缘; 红色	www.wago.com/2000-409/000-005
	型号: 2000-409/000-006 跨接器; 9插脚; 绝缘; 蓝色	www.wago.com/2000-409/000-006

变更声明。 敬请关注进一步的产品说明文件！

WAGO Electronic (Tianjin) Co., Ltd.
No.5, Quan Hui Road
Wuqing Development Area | Tianjin 301700
Tel.: +86 22 59677688 | Fax: +86 22 59617668
Email: info-cn@wago.com

您关于我们产品的任何问题吗？
我们非常乐意接听您的来电， +86 (022) 59677688。

	型号: 2000-410 跨接器; 10插脚; 绝缘; 浅灰色	www.wago.com/2000-410
	型号: 2000-410/000-005 跨接器; 10插脚; 绝缘; 红色	www.wago.com/2000-410/000-005
	型号: 2000-410/000-006 跨接器; 10插脚; 绝缘; 蓝色	www.wago.com/2000-410/000-006
	型号: 2000-433 跨接器; 从1到3; 绝缘; 浅灰色	www.wago.com/2000-433
	型号: 2000-433/000-005 跨接器; 从1到3; 绝缘; 红色	www.wago.com/2000-433/000-005
	型号: 2000-433/000-006 跨接器; 从1到3; 绝缘; 蓝色	www.wago.com/2000-433/000-006
	型号: 2000-434 跨接器; 从1到4; 绝缘; 浅灰色	www.wago.com/2000-434
	型号: 2000-435 跨接器; 从1到5; 绝缘; 浅灰色	www.wago.com/2000-435
	型号: 2000-436 跨接器; 从1到6; 绝缘; 浅灰色	www.wago.com/2000-436
	型号: 2000-437 跨接器; 从1到7; 绝缘; 浅灰色	www.wago.com/2000-437
	型号: 2000-438 跨接器; 从1到8; 绝缘; 浅灰色	www.wago.com/2000-438
	型号: 2000-439 跨接器; 从1到9; 绝缘; 浅灰色	www.wago.com/2000-439
	型号: 2000-440 跨接器; 从1到10; 绝缘; 浅灰色	www.wago.com/2000-440
	型号: 210-103 导线型跨接器; 绝缘; 黑色	www.wago.com/210-103
	型号: 210-123 导线型跨接器; 绝缘; 蓝色	www.wago.com/210-123
ferrule		
	型号: 216-241 冷压接头; 标识套管, 适用截面积 0.5 mm ² / AWG 20; 绝缘; 电镀锡; 电解铜; 气密压接; 符合DIN 46288-4 /09.09标准; 白色	www.wago.com/216-241
	型号: 216-242	

变更声明。敬请关注进一步的产品说明文件！

WAGO Electronic (Tianjin) Co., Ltd.
No.5, Quan Hui Road
Wuqing Development Area | Tianjin 301700
Tel.: +86 22 59677688 | Fax: +86 22 59617668
Email: info-cn@wago.com

您有关于我们产品的任何问题吗？
我们非常乐意接听您的来电，+86 (022) 59677688。



冷压接头; 标识套管, 适用截面积 0.75 mm² / AWG 18; 绝缘; 电镀锡; 电解铜; 气密压接; 符合DIN 46288-4 /09.09标准; 灰色 www.wago.com/216-242



型号: 216-243
冷压接头; 套管, 适于1 mm² / AWG 18; 绝缘; 电镀锡; 电解铜; 气密压接; 符合DIN 46288-4/09.09标准; 红色 www.wago.com/216-243

下载 文档

Bid Text

2200-1201 X81 - Datei	2019年2月19日	xml 3.8 kB	下载
2200-1201 docx - Datei	2018年8月8日	docx 14.9 kB	下载

Additional Information

Technical explanations	2019年4月3日	pdf 2.2 MB	下载
------------------------	-----------	---------------	----

CAD/CAE-Data

CAD data

2D/3D Models 2200-1201		URL	下载
------------------------	--	-----	----

CAE data

EPLAN Data Portal 2200-1201		URL	下载
ZUKEN Portal 2200-1201		URL	下载

Environmental Product Compliance

Compliance Search

Environmental Product Compliance 2200-1201 2线普通接线端子; 有推压键; 1 mm ² ; 有测试插孔; 侧面/中心标记; 适于35 x 15 和 35 x 7.5 导轨; Push-in CAGE CLAMP®; 1,00 mm ² ; 灰色		URL	下载
---	--	-----	----

变更声明。敬请关注进一步的产品说明文件！

WAGO Electronic (Tianjin) Co., Ltd.
No.5, Quan Hui Road
Wuqing Development Area | Tianjin 301700
Tel.: +86 22 59677688 | Fax: +86 22 59617668
Email: info-cn@wago.com

您关于我们产品的任何问题吗？
我们非常乐意接听您的来电， +86 (022) 59677688。

Installation Notes

连接导线

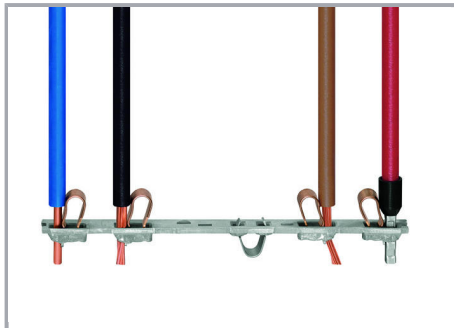

All conductor types at a glance

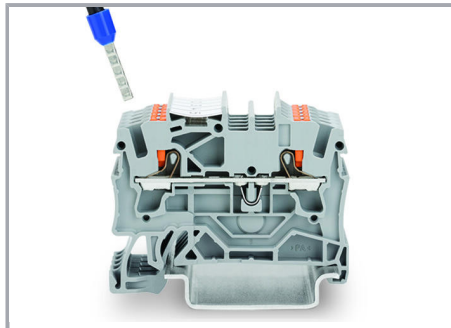

Push-in termination of solid and ferruled conductors



Insert fine-stranded conductors via operating tool.



Removing all conductors via operating tool.

跨接

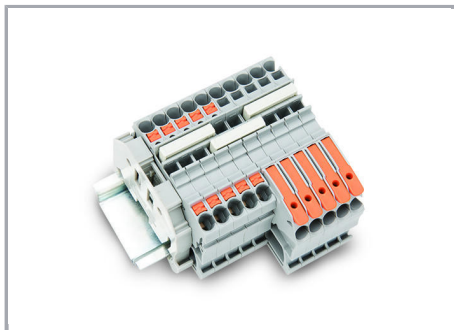

Insert a push-in type jumper bar and push down until it hits the backstop.

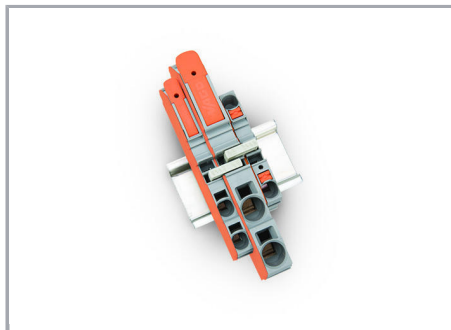

Commoning with step-down jumpers.

测试

变更声明。 敬请关注进一步的产品说明文件！

WAGO Electronic (Tianjin) Co., Ltd.
No.5, Quan Hui Road
Wuqing Development Area | Tianjin 301700
Tel.: +86 22 59677688 | Fax: +86 22 59617668
Email: info-cn@wago.com

您有关于我们产品的任何问题吗？
我们非常乐意接听您的来电， +86 (022) 59677688。

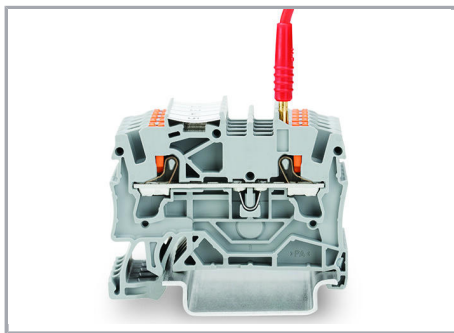

Testing with a 2 mm Ø test plug (max. 42 V).

标记

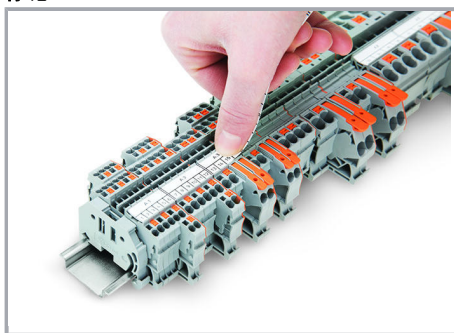

Snapping a marking strip into a marker slot.

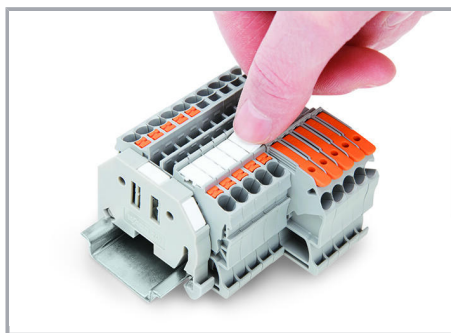

Snapping a marking strip into the marker slot.

产品系列

TOPJOB® S

TOPJOB® S: In various industrial applications and modern building installations, WAGO's wide and versatile range of rail-mount terminal blocks provides more than just reliable electrical connections.

[显示该系列的所有产品。](#)

变更声明。 敬请关注进一步的产品说明文件！

WAGO Electronic (Tianjin) Co., Ltd.
No.5, Quan Hui Road
Wuqing Development Area | Tianjin 301700
Tel.: +86 22 59677688 | Fax: +86 22 59617668
Email: info-cn@wago.com

您有关于我们产品的任何问题吗？
我们非常乐意接听您的来电， +86 (022) 59677688。